

Lecture 20

Machine Translation

Nathan Schneider

(with slides by Philipp Koehn, Marine Carpuat,
Chris Dyer)

ENLP | 27, 29 April 2021

A Clear Plan

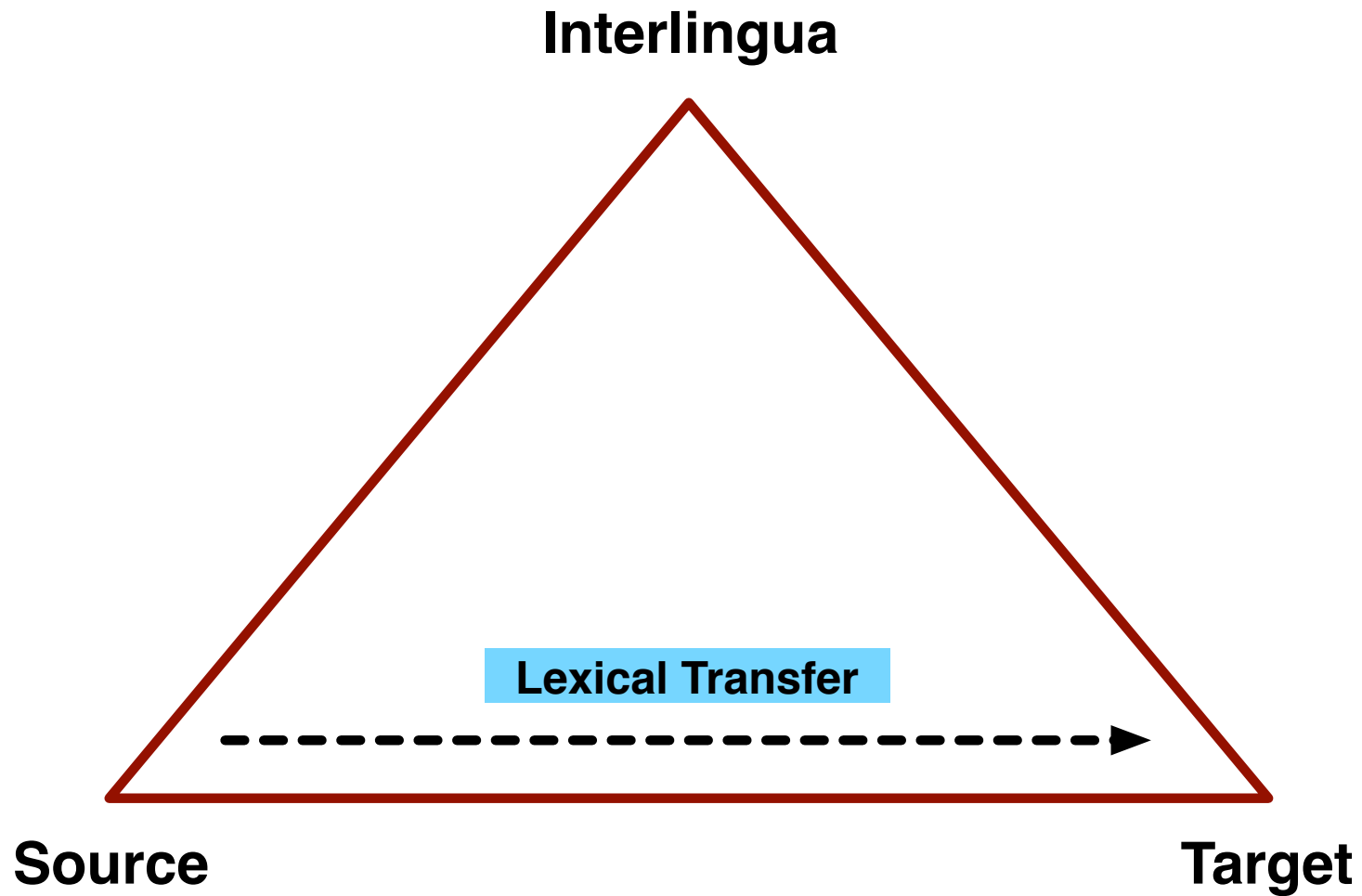

Word Order Variation

The [golden line](#) in Latin literature can be represented schematically as ABVAB where the A's and B's form NP constituents and V is a verb. Example from the *Aeneid*:

aurea	purpuream	subnectit	fibula	vestem
golden.NOM	purple.ACC	fastens	clasp.NOM	cloak.ACC

'golden clasp fastens purple cloak'

Would the dependency parse be
projective or **nonprojective**?

(courtesy Luke Gessler)

A Clear Plan

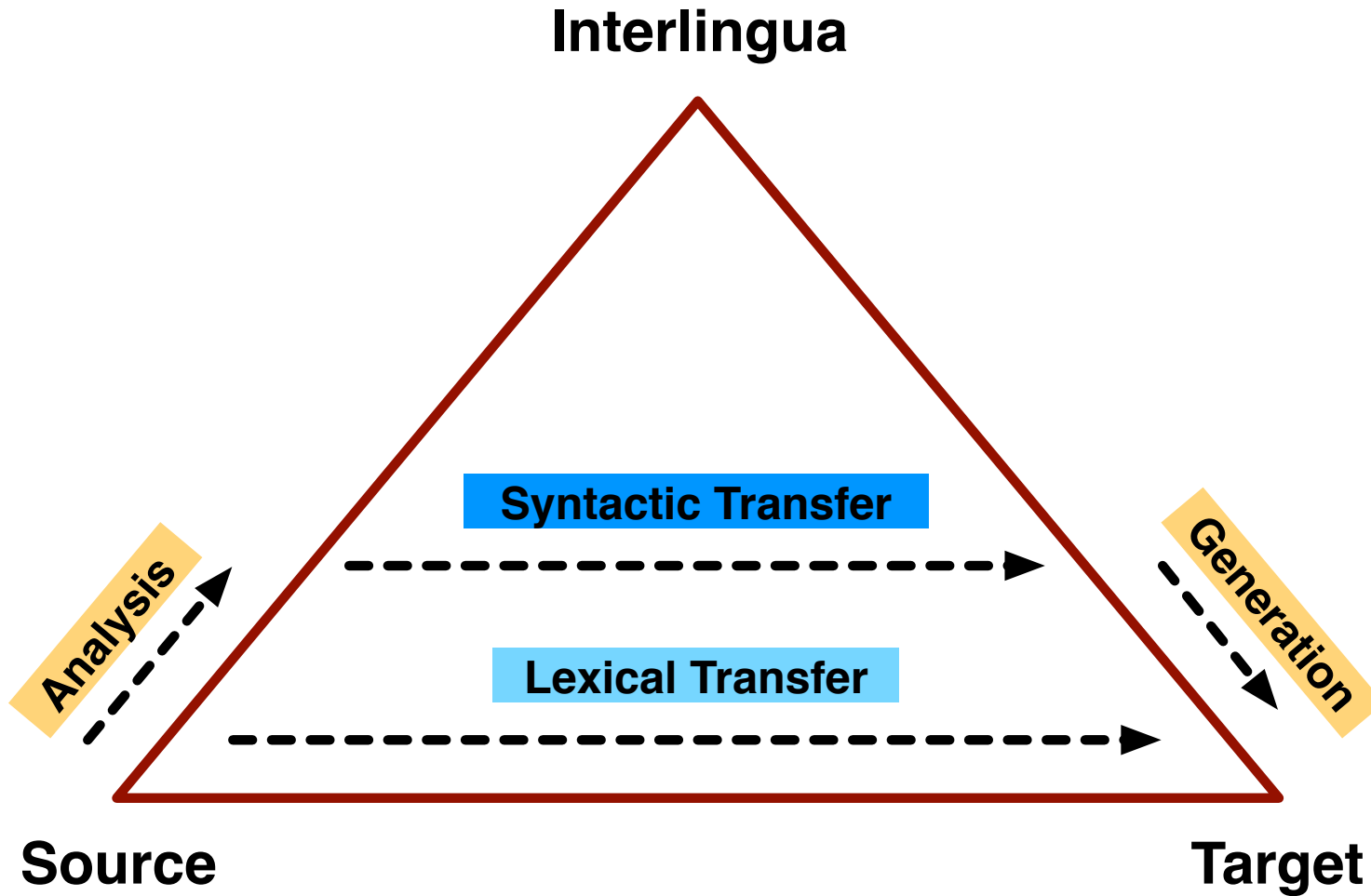

A Clear Plan

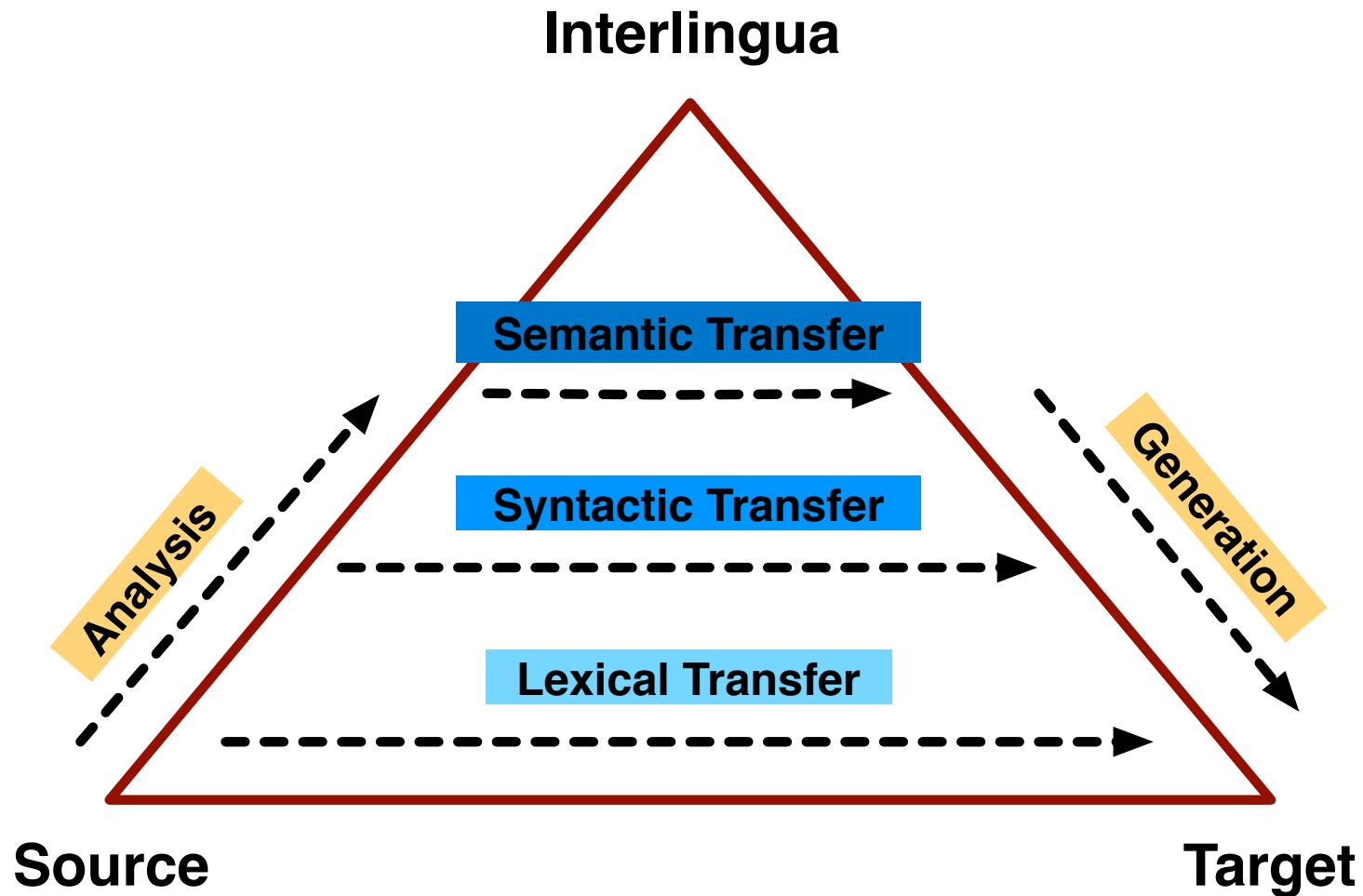

A Clear Plan

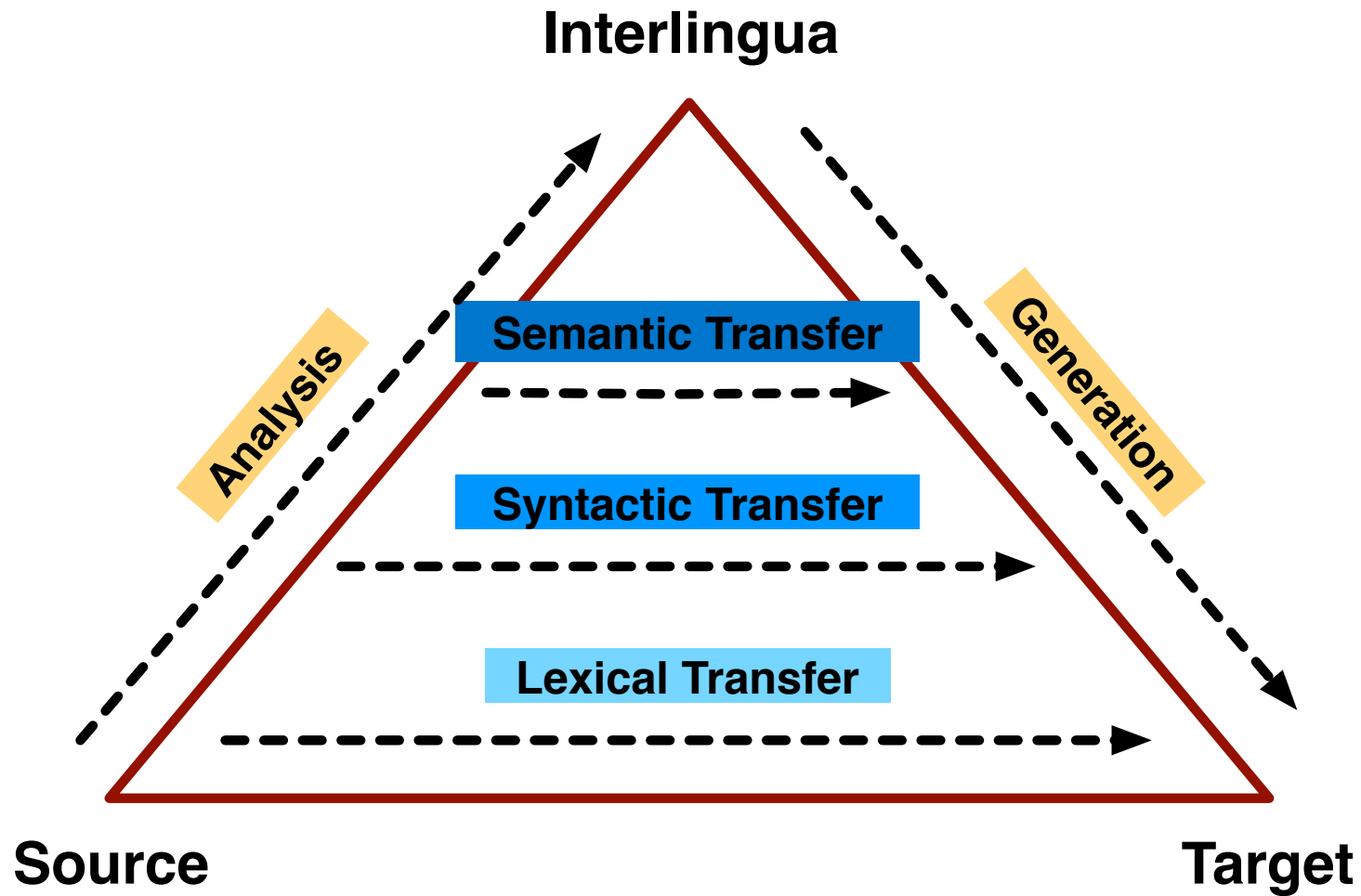

Evaluation

Problem: No Single Right Answer

这个机场的安全工作由以色列方面负责。

Israeli officials are responsible for airport security.

Israel is in charge of the security at this airport.

The security work for this airport is the responsibility of the Israel government.

Israeli side was in charge of the security of this airport.

Israel is responsible for the airport's security.

Israel is responsible for safety work at this airport.

Israel presides over the security of the airport.

Israel took charge of the airport security.

The safety of this airport is taken charge of by Israel.

This airport's security is the responsibility of the Israeli security officials.

Human Evaluation

- Manually **score** or **rank** candidate translations
 - ▶ e.g., for **fluency** (target language grammaticality/naturalness) and **adequacy** (respecting the meaning of the source sentence)

Human Evaluation

- Manually **score** or **rank** candidate translations
 - ▶ e.g., for **fluency** (target language grammaticality/naturalness) and **adequacy** (respecting the meaning of the source sentence)
- Manually **edit** the system output until it is an acceptable reference translation (**HTER = Human Translation Edit Rate**)
 - ▶ insertions, substitutions, deletions, shifts (moving a word or phrase)
 - ▶ then measure # edits / # words in reference (i.e., 1 – recall)

Automatic evaluation

- Why **automatic evaluation** metrics?
 - Manual evaluation is *too slow*
 - Evaluation on large test sets *reveals minor improvements*
 - **Automatic tuning** to improve machine translation performance
- History
 - Word Error Rate
 - **BLEU** since 2002
- BLEU in short: *Overlap with reference* translations

Automatic evaluation

- Reference Translation
 - the gunman was shot to death by the police .
- System Translations
 - the gunman was police kill .
 - wounded police jaya of
 - the gunman was shot dead by the police .
 - the gunman arrested by police kill .
 - the gunmen were killed .
 - the gunman was shot to death by the police .
 - gunmen were killed by police ?SUB>0 ?SUB>0
 - al by the police .
 - the ringer is killed by the police .
 - police killed the gunman .
- Matches
 - green = 4 gram match (good!)
 - red = word not matched (bad!)

Automatic evaluation

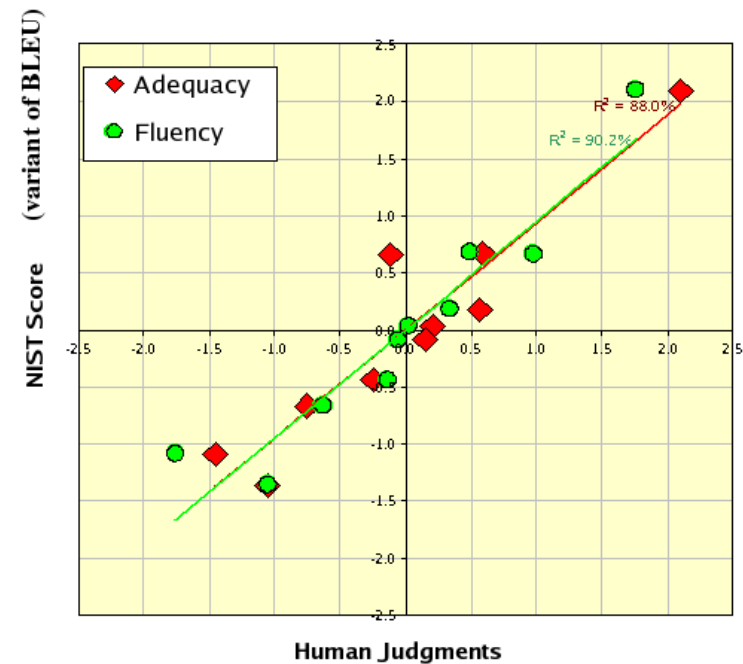

[from George Doddington, NIST]

- BLEU **correlates** with human judgement
 - **multiple reference translations** may be used

what is it good for?

what is it good *enough* for?

HTER **assessment**

0%	
10%	publishable
20%	editable
30%	gistable
40%	triagable
50%	

(scale developed in preparation of DARPA GALE programme)

Applications

HTER	assessment	application examples
0%	publishable	Seamless bridging of language divide
10%		Automatic publication of official announcements
20%	editable	Increased productivity of human translators
30%		Access to official publications
40%	gistable	Multi-lingual communication (chat, social networks)
50%		Information gathering
	triagable	Trend spotting
		Identifying relevant documents

Current State of the Art

HTER	assessment	language pairs and domains
0%		
	publishable	French-English restricted domain
10%		French-English technical document localization
	editable	French-English news stories
20%		
		English-German news stories
30%	gistable	English-Czech open domain
40%	triagable	
50%		

(informal rough estimates by presenter)

Machine Translation

CMSC 723 / LING 723 / INST 725

MARINE CARPUAT

marine@cs.umd.edu

Today: an introduction to machine translation

- The **noisy channel model** decomposes machine translation into
 - Word alignment
 - Language modeling
- How can we automatically **align words** within sentence pairs? We'll rely on:
 - **probabilistic modeling**
 - IBM1 and variants [Brown et al. 1990]
 - **unsupervised learning**
 - Expectation Maximization algorithm

MACHINE TRANSLATION AS A NOISY CHANNEL MODEL

The flowers bloom in the spring.

कलियाँ वसन्त में खिलती हैं ।

Sita came yesterday.

सीता कल आयी थी ।

The gymnast makes springing up to the bar look easy.

कसरतबाज डंडे के ऊपर से कूदने के कार्य को आसान बना देता है ।

It rained yesterday.

कल बारिश हुई थी ।

School will commence tomorrow.

विद्यालय कल से आरम्भ होगा ।

With a spring the cat reached the branch.

वह बिल्ली एक टहनी पर कूद गयी ।

I will come tomorrow.

मैं कल आऊँगा ।

The flowers bloom in the spring.

कलियाँ वसन्त में खिलती हैं ।

Sita came yesterday.

सीता कल आयी थी ।

The gymnast makes springing up to the bar look easy.

कसरतबाज डंडे के ऊपर से कूदने के कार्य को आसान बना देता है ।

It rained yesterday.

कल बारिश हुई थी ।

School will commence tomorrow.

विद्यालय कल से आरम्भ होगा ।

With a spring the cat reached the branch.

वह बिल्ली एक टहनी पर कूद गयी ।

I will come tomorrow.

मैं कल आऊँगा ।

The flowers bloom in the spring.

कलियाँ वसन्त में खिलती हैं ।

Sita came yesterday.

सीता कल आयी थी ।

The gymnast makes springing up to the bar look easy.

कसरतबाज डंडे के ऊपर से कूदने के कार्य को आसान बना देता है ।

It rained yesterday.

कल बारिश हुई थी ।

School will commence tomorrow.

विद्यालय कल से आरम्भ होगा ।

With a spring the cat reached the branch.

वह बिल्ली एक टहनी पर कूद गयी ।

I will come tomorrow.

मैं कल आऊँगा ।

The flowers bloom in the spring.

कलियाँ वसन्त में खिलती हैं ।

Sita came yesterday.

सीता कल आयी थी ।

The gymnast makes springing up to the bar look easy.

कसरतबाज डंडे के ऊपर से कूदने के कार्य को आसान बना देता है ।

It rained yesterday.

कल बारिश हुई थी ।

School will commence tomorrow.

विद्यालय कल से आरम्भ होगा ।

With a spring the cat reached the branch.

वह बिल्ली एक टहनी पर कूद गयी ।

I will come tomorrow.

मैं कल आऊँगा ।

The flowers bloom in the spring.

कलियाँ वसन्त में खिलती हैं ।

Sita came yesterday.

सीता कल आयी थी ।

The gymnast makes springing up to the bar look easy.

कसरतबाज डंडे के ऊपर से कूदने के कार्य को आसान बना देता है ।

It rained yesterday.

कल बारिश हुई थी ।

School will commence tomorrow.

विद्यालय कल से आरम्भ होगा ।

With a spring the cat reached the branch.

वह बिल्ली एक टहनी पर कूद गयी ।

I will come tomorrow.

मैं कल आऊँगा ।

The flowers bloom in the spring.

कलियाँ वसन्त में खिलती हैं ।

Sita came yesterday.

सीता कल आयी थी ।

The gymnast makes springing up to the bar look easy.

कसरतबाज डंडे के ऊपर से कूदने के कार्य को आसान बना देता है ।

It rained yesterday.

कल बारिश हुई थी ।

School will commence tomorrow.

विद्यालय कल से आरम्भ होगा ।

With a spring the cat reached the branch.

वह बिल्ली एक टहनी पर कूद गयी ।

I will come tomorrow.

मैं कल आऊँगा ।

The flowers bloom in the spring.

कलियाँ वसन्त में खिलती हैं ।

Sita came yesterday.

सीता कल आयी थी ।

The gymnast makes springing up to the bar look easy.

कसरतबाज डंडे के ऊपर से कूदने के कार्य को आसान बना देता है ।

It rained yesterday.

कल बारिश हुई थी ।

School will commence tomorrow.

विद्यालय कल से आरम्भ होगा ।

With a spring the cat reached the branch.

वह बिल्ली एक टहनी पर कूद गयी ।

I will come tomorrow.

मैं कल आऊँगा ।

Rosetta Stone

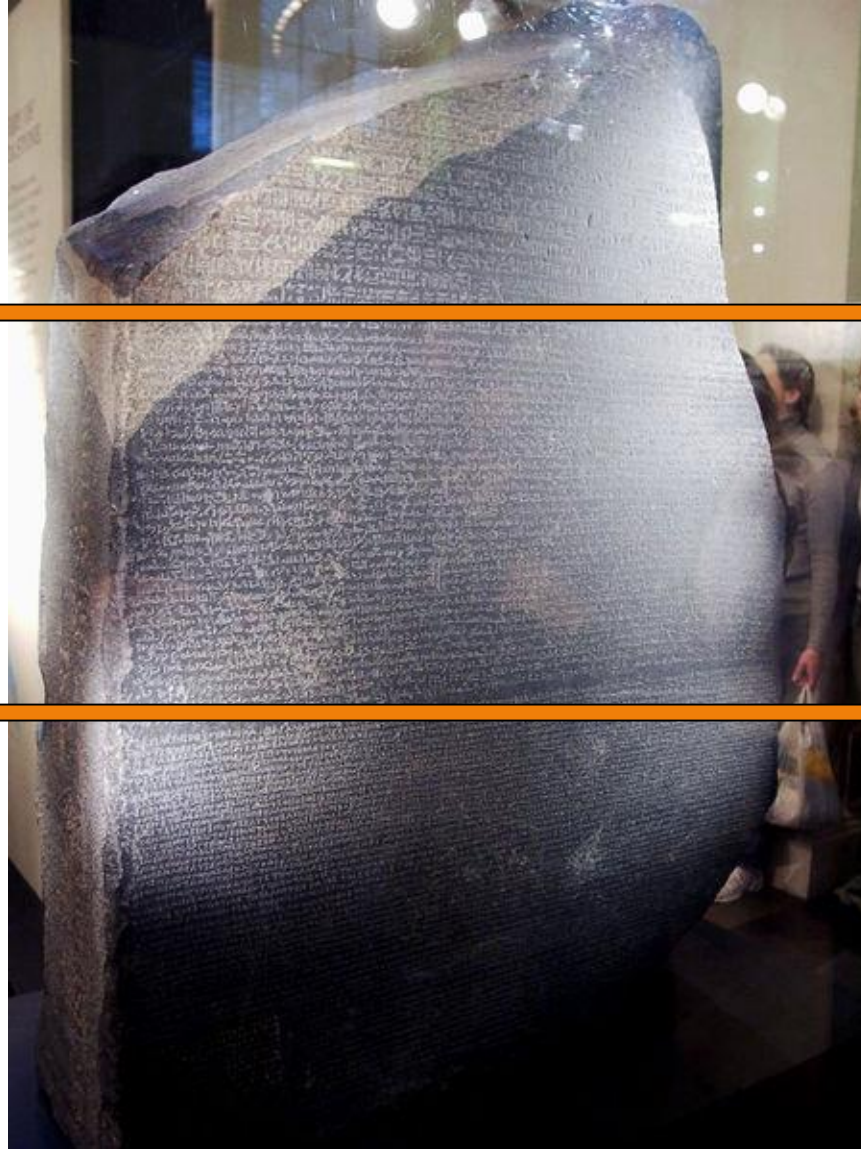

Egyptian
hieroglyphs

Demotic

Greek

Warren Weaver (1947)

When I look at an article in Russian, I say to myself: This is really written in English, but it has been coded in some strange symbols. I will now proceed to decode.



Weaver's intuition formalized as a Noisy Channel Model

- Translating a French sentence **f** is finding the English sentence **e** that maximizes **P(ef)**
- The noisy channel model breaks down **P(ef)** into two components

$$\hat{E} = \operatorname{argmax}_{E \in \text{English}} \underbrace{P(F|E)}_{\text{translation model}} \underbrace{P(E)}_{\text{language model}}$$

Translation Model & Word Alignments

- How can we define the translation model $p(f|e)$ between a French sentence f and an English sentence e ?
- Problem: there are many possible sentences!
- Solution: break sentences into words
 - model mappings between word position to represent translation
 - Just like in the Centauri/Arcturian example

PROBABILISTIC MODELS OF WORD ALIGNMENT

Defining a probabilistic model for word alignment

Probability lets us

- 1) Formulate a **model** of pairs of sentences
- 2) **Learn** an instance of the model from **data**
- 3) Use it to **infer** alignments of new inputs

Recall language modeling

Probability lets us

1) Formulate a **model** of a sentence

e.g, bi-grams

2) **Learn** an instance of the model from **data**

$$\hat{p}_{\text{MLE}}(\text{call} \mid \text{friends}) = \frac{\text{count}(\text{friends call})}{\text{count}(\text{friends})}$$

3) Use it to **score new sentences**

How can we model $p(f|e)$?

- We'll describe the word alignment models introduced in early 90s at IBM
- Assumption: each French word f is aligned to exactly one English word e
 - Including NULL

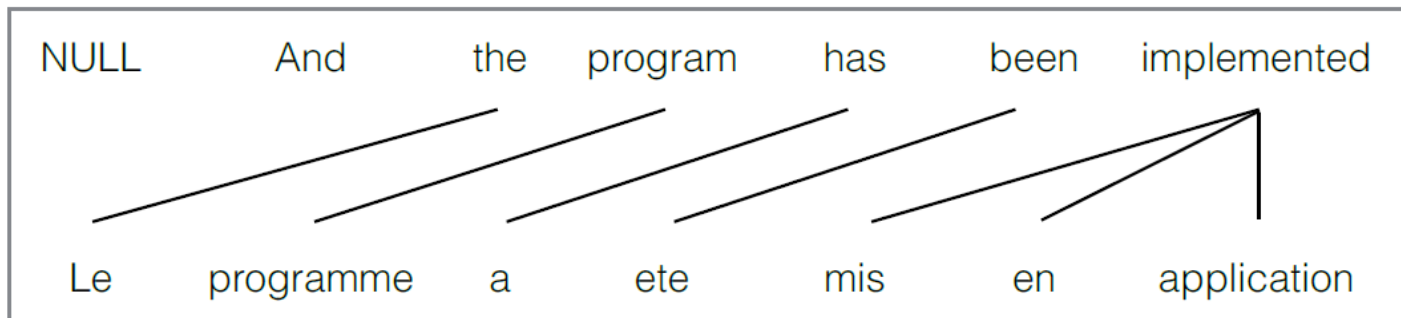

Word Alignment Vector Representation

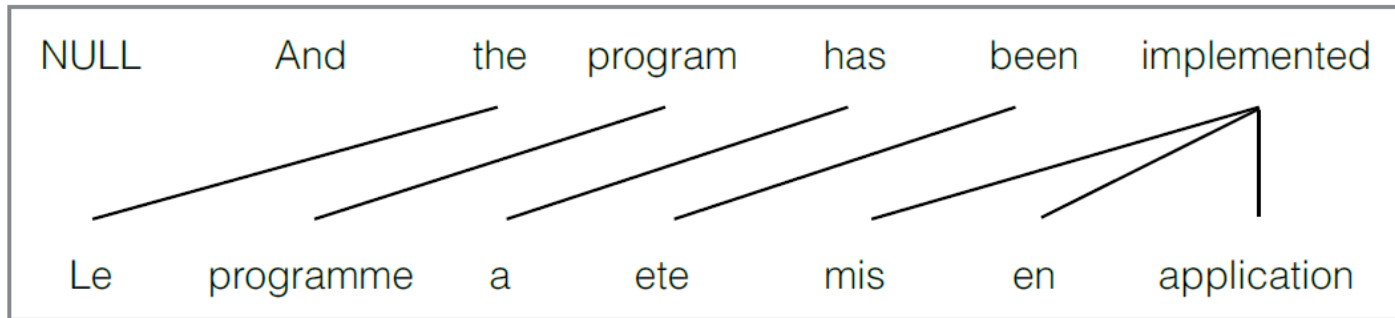

- Alignment vector $a = [2,3,4,5,6,6,6]$
 - length of a = length of sentence f
 - $a_i = j$ if French position i is aligned to English position j

Word Alignment Vector Representation

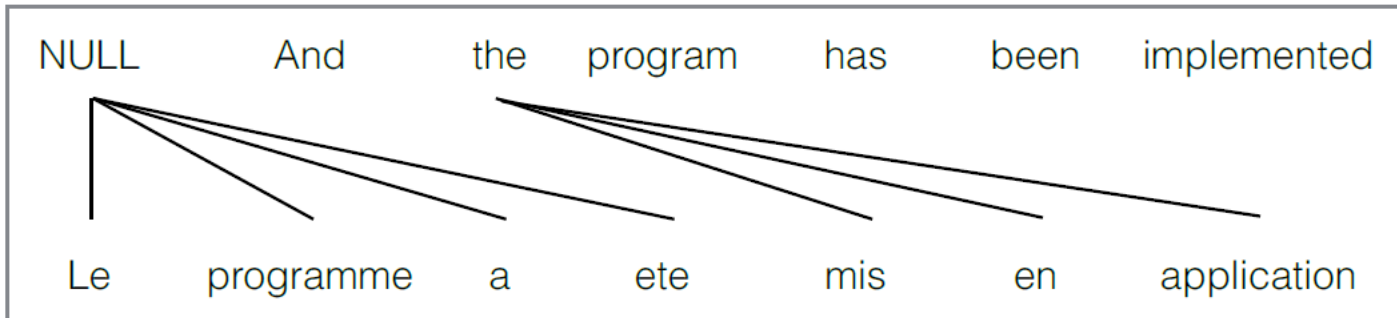

- Alignment vector $a = [0,0,0,0,2,2,2]$

How many possible alignments?

- How many possible alignments for (f,e) where
 - f is French sentence with m words
 - e is an English sentence with l words
- For each of m French words, we choose an alignment link among $(l+1)$ English words
- Answer: $(l+1)^m$

Formalizing the connection between word alignments & the translation model

$$p(f_1, f_2, \dots, f_m \mid e_1, e_2, \dots, e_l, m)$$
$$= \sum_{a \in A} p(f_1, \dots, f_m, a_1, \dots, a_m \mid e_1, \dots, e_l, m)$$

- We define a **conditional model**
 - Projecting word translations
 - Through alignment links

IBM Model 1: generative story

- Input
 - an English sentence of length l
 - a length m
- For each French position i in $1..m$
 - Pick an English source index j $q(j | i, l, m) = \frac{1}{l + 1}$
 - Choose a translation $t(f_i | e_{a_i})$

IBM Model 1: generative story

- Input
 - an English sentence of length l
 - a length m

Alignment is based on word positions, not word identities

Alignment probabilities are UNIFORM

- For each French position i in $1..m$

- Pick an English source index j $q(j | i, l, m) = \frac{1}{l + 1}$

- Choose a translation

$$t(f_i | e_{a_i})$$

Words are translated independently

IBM Model 1: Parameters

- $t(f|e)$
 - Word translation probability table
 - for all words in French & English vocab

f	e	$p(f e)$
le	the	0.42
la	the	0.4
programme	the	0.001
a	has	0.78
...

IBM Model 1: generative story

- Input
 - an English sentence of length l
 - a length m
- For each French position i in $1..m$

– Pick an English source index j $q(j | i, l, m) = \frac{1}{l + 1}$

– Choose a translation $t(f_i | e_{a_i})$

$$p(f_1 \dots f_m, a_1 \dots a_m | e_1 \dots e_l, m) = \prod_{i=1}^m q(a_i | i, l, m) t(f_i | e_{a_i})$$

IBM Model 1: Example

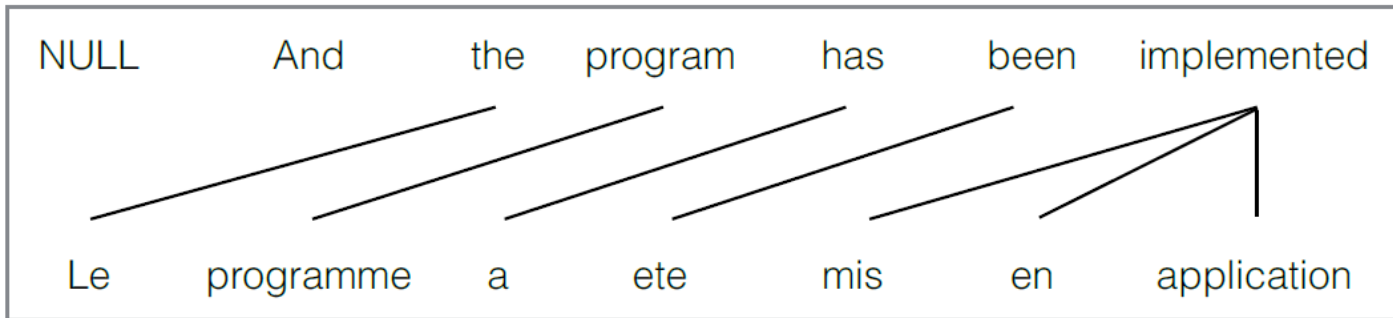

- Alignment vector $a = [2,3,4,5,6,6,6]$
- $P(f,a|e)$?

Improving on IBM Model 1: IBM Model 2

- Input
 - an English sentence of length l
 - a length m
- For each French position i in $1..m$
 - Pick an English source index j $q(j | i, l, m)$
 - Choose a translation $t(f_i | e_{a_i})$

Remove
assumption that q
is uniform

IBM Model 2: Parameters

- $q(j|i,l,m)$
 - now a table
 - not uniform as in IBM1
- How many parameters are there?

j	$q(j 1, 6, 7)$
1	0.27
2	0.14
...	...
48	1E-75

Defining a probabilistic model for word alignment

Probability lets us

- 1) Formulate a **model** of pairs of sentences
=> IBM models 1 & 2
- 2) **Learn** an instance of the model from **data**
- 3) Use it to **infer** alignments of new inputs

2 Remaining Tasks

Inference

- Given
 - a sentence pair (e, f)
 - an alignment model with parameters $t(e|f)$ and $q(j|i, l, m)$
- What is the most probable alignment a ?

Parameter Estimation

- Given
 - training data (lots of sentence pairs)
 - a model definition
- how do we learn the parameters $t(e|f)$ and $q(j|i, l, m)$?

Inference

- Inputs
 - Model parameter tables for t and q
 - A sentence pair

NULL	And	the	program	has	been	implemented
Le	programme	a	ete	mis	en	application

- How do we find the alignment a that maximizes $P(e,a|f)$?
 - Hint: recall independence assumptions!

Inference

- Inputs
 - Model parameter tables for t and q
 - A sentence pair

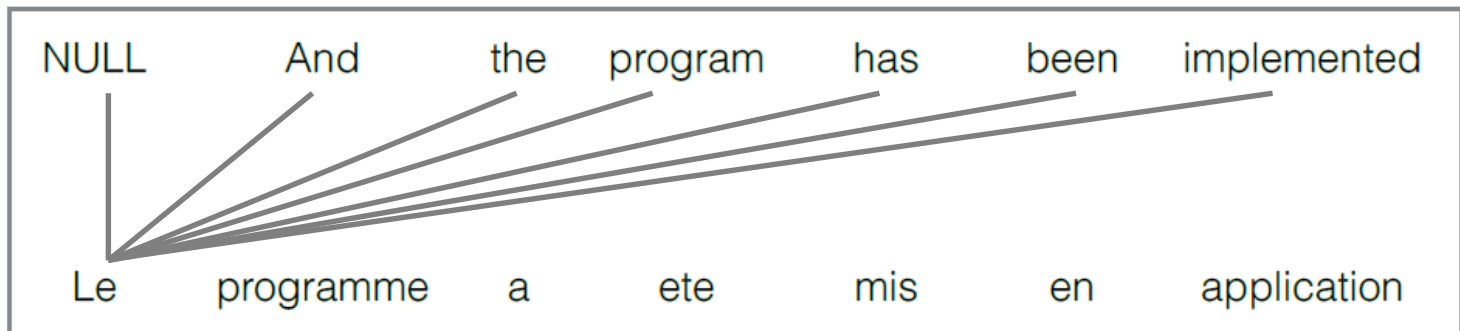

- How do we find the alignment a that maximizes $P(e,a|f)$?
 - Hint: recall independence assumptions!

Inference

- Inputs
 - Model parameter tables for t and q
 - A sentence pair

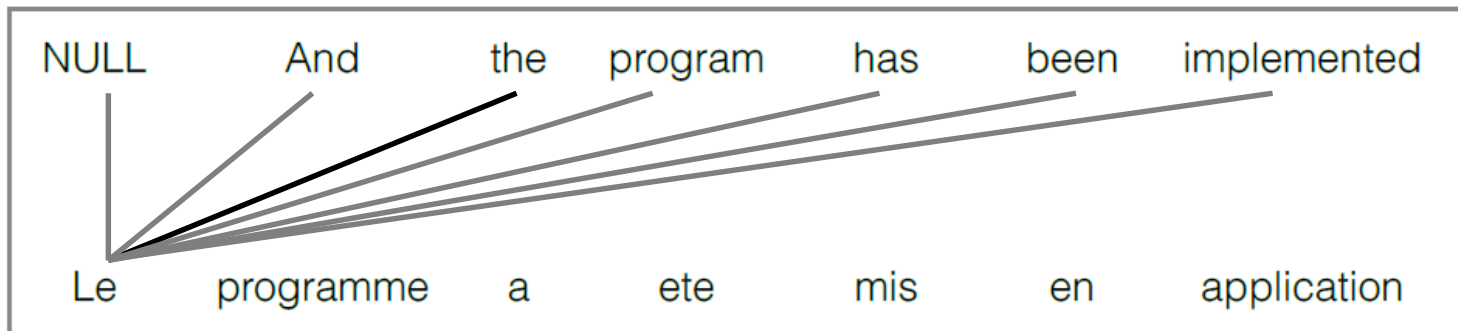

- How do we find the alignment a that maximizes $P(e,a|f)$?
 - Hint: recall independence assumptions!

Inference

- Inputs
 - Model parameter tables for t and q
 - A sentence pair

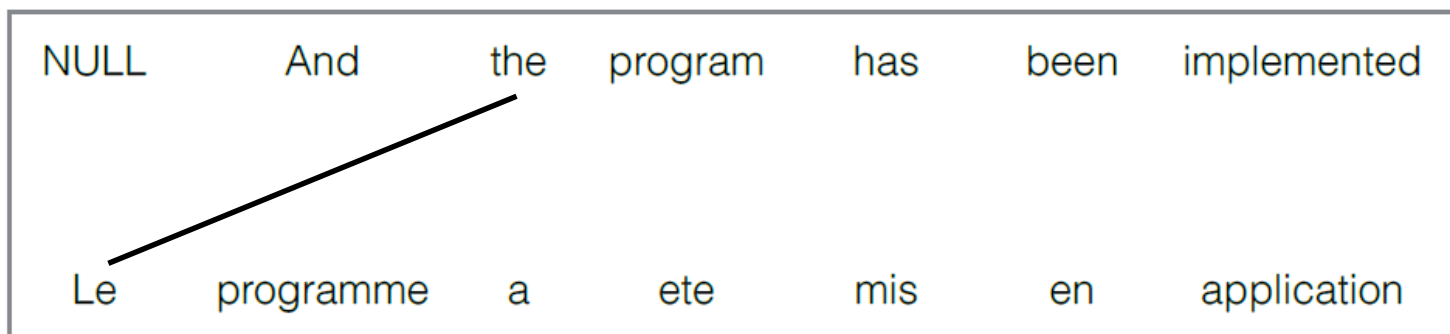

- How do we find the alignment a that maximizes $P(e,a|f)$?
 - Hint: recall independence assumptions!

Inference

- Inputs
 - Model parameter tables for t and q
 - A sentence pair

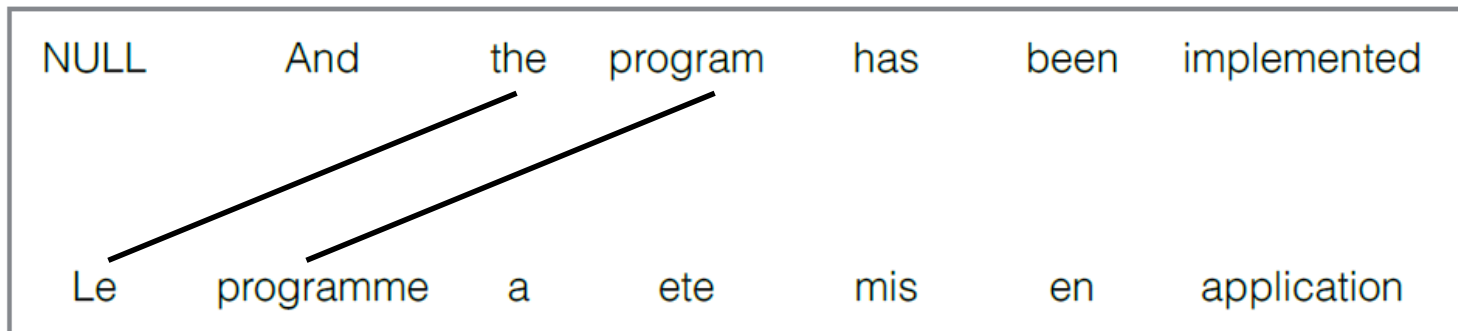

- How do we find the alignment a that maximizes $P(e,a|f)$?
 - Hint: recall independence assumptions!

Inference

- Inputs
 - Model parameter tables for t and q
 - A sentence pair

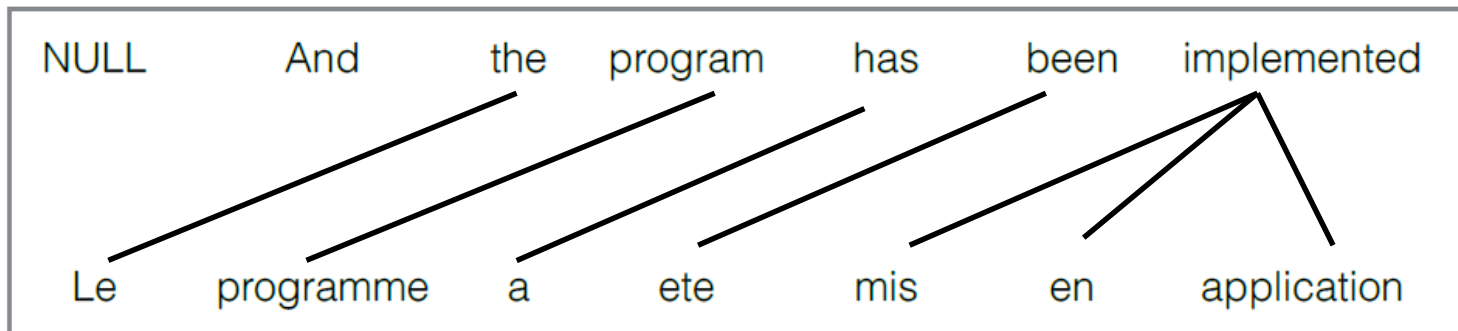

- How do we find the alignment a that maximizes $P(e,a|f)$?
 - Hint: recall independence assumptions!

Alignment Error Rates: How good is the prediction?

- Given: predicted alignments A , sure links S , and possible links P

- Precision: $\frac{|A \cap P|}{|A|}$ Recall: $\frac{|A \cap S|}{|S|}$

- $AER(A|S,P) = 1 - \frac{|A \cap P| + |A \cap S|}{|A| + |S|}$

Reference alignments, with Possible links and Sure links

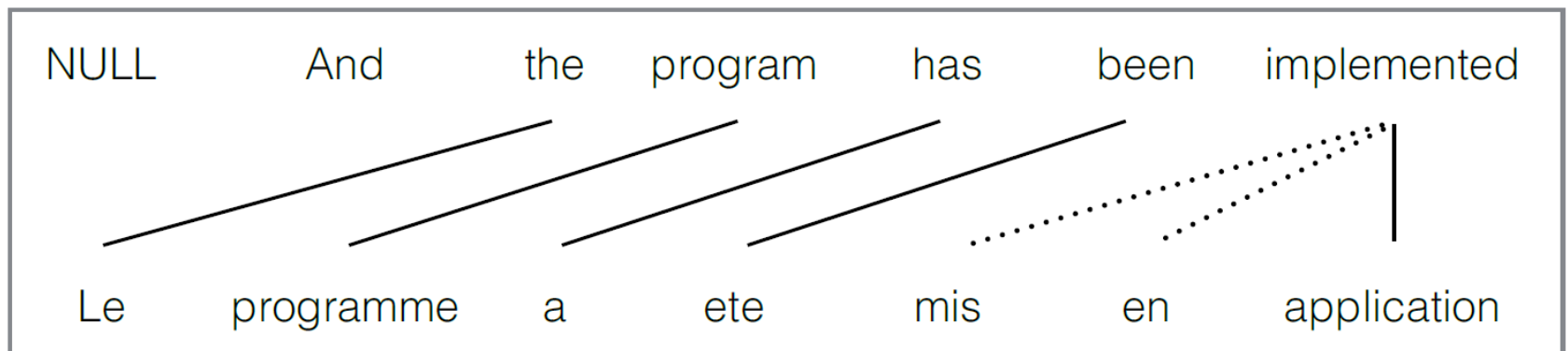

1 Remaining Task

Inference

- Given a sentence pair (e, f) , what is the most probable alignment a ?

Parameter Estimation

- How do we learn the parameters $t(e|f)$ and $q(j|i, l, m)$ from data?

Parameter Estimation (warm-up)

- Inputs
 - Model definition (t and q)
 - A corpus of sentence pairs, with word alignment

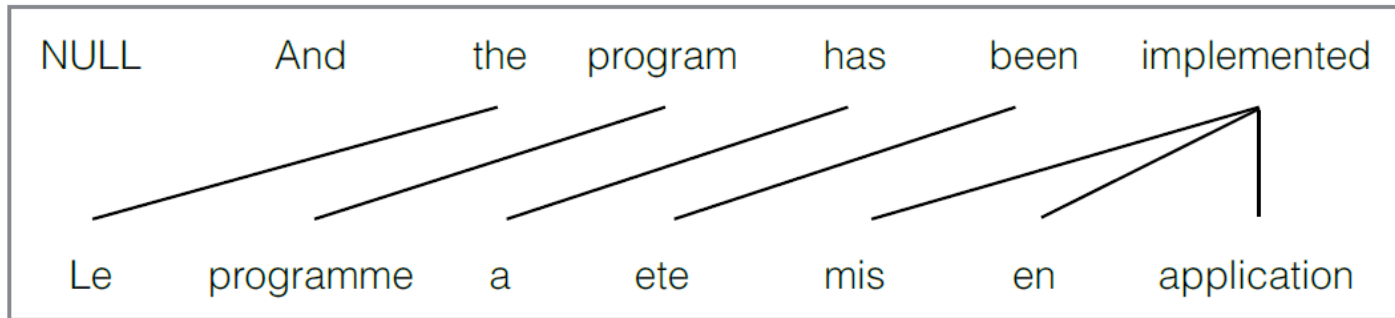

- How do we build tables for t and q ?
 - Use counts, just like for n-gram models!

Parameter Estimation (for real)

- Problem
 - Parallel corpus gives us (\mathbf{e}, \mathbf{f}) pairs only, \mathbf{a} is **hidden**
- We know how to
 - estimate \mathbf{t} and \mathbf{q} , given $(\mathbf{e}, \mathbf{a}, \mathbf{f})$
 - compute $\mathbf{p}(\mathbf{e}, \mathbf{a} | \mathbf{f})$, given \mathbf{t} and \mathbf{q}
- Solution: Expectation-Maximization algorithm (EM)
 - E-step: given hidden variable, estimate parameters
 - M-step: given parameters, update hidden variable

Parameter Estimation: hard EM

Algorithm 1 (hard EM)

```
initialize parameters  $t$  and  $q$  to something
repeat until convergence
  for every sentence
    for every target position  $j$ 
      for every source position  $i$ 
        if aligned( $i, j$ )
          count( $f_j | e_i$ ) += 1
          count( $e_i$ ) += 1
          count( $j, i, l, m$ ) += 1
          count( $i, l, m$ ) += 1
 $t(f | e) = \text{count}(f, e) / \text{count}(e)$ 
 $q(j | i, l, m) = \text{count}(j, i, l, m) / \text{count}(i, l, m)$ 
```

Parameter Estimation: soft EM

initialize parameters t and q to something
repeat until convergence

for every sentence

for every target position j

for every source position i

$$\text{count}(f_j, e_i) += P(a_i = j \mid e_i, f_j)$$

$$\text{count}(e_i) += P(a_i = j \mid e_i, f_j)$$

$$\text{count}(j, i, l, m) += P(a_i = j \mid e_i, f_j)$$

$$\text{count}(i, l, m) += P(a_i = j \mid e_i, f_j)$$

$$t(f \mid e) = \text{count}(f, e) / \text{count}(e)$$

$$q(j \mid i, l, m) = \text{count}(j, i, l, m) / \text{count}(i, l, m)$$

Use "Soft" values
instead of binary
counts

Algorithm 1 (soft EM)

Parameter Estimation: soft EM

- Soft EM considers all possible alignment links
- Each alignment link now has a weight

$$P(a_i = j \mid e_i, f_j) = \frac{q(j \mid i, l, m) \cdot t(f_i \mid e_j)}{\sum_{j'=1}^l q(j' \mid i, l, m) \cdot t(f_i \mid e_{j'})}$$

Example: learning t table using EM for IBM1

das Haus

 the house

das Buch

 the book

ein Buch

 a book

e	f	initial	1st it.	2nd it.	3rd it.	...	final
the	das	0.25	0.5	0.6364	0.7479	...	1
book	das	0.25	0.25	0.1818	0.1208	...	0
house	das	0.25	0.25	0.1818	0.1313	...	0
the	buch	0.25	0.25	0.1818	0.1208	...	0
book	buch	0.25	0.5	0.6364	0.7479	...	1
a	buch	0.25	0.25	0.1818	0.1313	...	0
book	ein	0.25	0.5	0.4286	0.3466	...	0
a	ein	0.25	0.5	0.5714	0.6534	...	1
the	haus	0.25	0.5	0.4286	0.3466	...	0
house	haus	0.25	0.5	0.5714	0.6534	...	1

We have now fully specified our probabilistic alignment model!

Probability lets us

- 1) Formulate a **model** of pairs of sentences
=> **IBM models 1 & 2**
- 2) **Learn** an instance of the model from **data**
=> **using EM**
- 3) Use it to **infer** alignments of new inputs
=> **based on independent translation decisions**

Summary: Noisy Channel Model for Machine Translation

- The **noisy channel model** decomposes machine translation into two independent subproblems
 - Word alignment
 - Language modeling

$$\hat{E} = \operatorname{argmax}_{E \in \text{English}} \overbrace{P(F|E)}^{\text{translation model}} \overbrace{P(E)}^{\text{language model}}$$

Summary: Word Alignment with IBM Models 1, 2

- Probabilistic models with **strong independence assumptions**
 - Results in linguistically naïve models
 - asymmetric, 1-to-many alignments
 - But allows efficient parameter estimation and inference
- Alignments are hidden variables
 - unlike words which are observed
 - require **unsupervised learning** (EM algorithm)

Today

- Walk through an example of EM
- Phrase-based Models
 - A slightly more recent translation model
- Decoding

EM FOR IBM1

IBM Model 1: generative story

- Input
 - an English sentence of length l
 - a length m
- For each French position i in $1..m$

– Pick an English source index j $q(j | i, l, m) = \frac{1}{l + 1}$

– Choose a translation $t(f_i | e_{a_i})$

$$p(f_1 \dots f_m, a_1 \dots a_m | e_1 \dots e_l, m) = \prod_{i=1}^m q(a_i | i, l, m) t(f_i | e_{a_i})$$

EM for IBM Model 1

- Expectation (E)-step:
 - Compute expected counts for parameters (t) based on summing over hidden variable
- Maximization (M)-step:
 - Compute the maximum likelihood estimate of t from the expected counts

EM example: initialization

green house

the house

casa verde

la casa

$t(\text{casa} \text{green}) = \frac{1}{3}$	$t(\text{verde} \text{green}) = \frac{1}{3}$	$t(\text{la} \text{green}) = \frac{1}{3}$
$t(\text{casa} \text{house}) = \frac{1}{3}$	$t(\text{verde} \text{house}) = \frac{1}{3}$	$t(\text{la} \text{house}) = \frac{1}{3}$
$t(\text{casa} \text{the}) = \frac{1}{3}$	$t(\text{verde} \text{the}) = \frac{1}{3}$	$t(\text{la} \text{the}) = \frac{1}{3}$

For the rest of this talk, French = Spanish

EM

green house
| |
casa verde
 $P(a, f|e) = t(\text{casa, green})$
 $\times t(\text{verde, house})$

green house
 \ /
 / \
casa verde
 $P(a, f|e) = t(\text{verde, green})$
 $\times t(\text{casa, house})$

the house
| |
la casa
 $P(a, f|e) = t(\text{la, the})$
 $\times t(\text{casa, house})$

the house
 \ /
 / \
la casa
 $P(a, f|e) = t(\text{casa, the})$
 $\times t(\text{la, house})$

E step: Unnormalized Expected Counts

$c(\text{casa}|\text{green}) =$ $c(\text{verde}|\text{green}) =$ $c(\text{la}|\text{green}) =$ $\text{total}(\text{green}) =$

$c(\text{casa}|\text{house}) =$ $c(\text{verde}|\text{house}) =$ $c(\text{la}|\text{house}) =$ $\text{total}(\text{house}) =$

$c(\text{casa}|\text{the}) =$ $c(\text{verde}|\text{the}) =$ $c(\text{la}|\text{the}) =$ $\text{total}(\text{the}) =$

M step: Normalized Probabilities

$t(\text{casa}|\text{green}) =$ $t(\text{verde}|\text{green}) =$ $t(\text{la}|\text{green}) =$ $\text{total}(\text{green}) = 1$

$t(\text{casa}|\text{house}) =$ $t(\text{verde}|\text{house}) =$ $t(\text{la}|\text{house}) =$ $\text{total}(\text{house}) = 1$

$t(\text{casa}|\text{the}) =$ $t(\text{verde}|\text{the}) =$ $t(\text{la}|\text{the}) =$ $\text{total}(\text{the}) = 1$

EM example: E-step

(a) compute probability of each alignment $p(a|f,e)$

<p>green house casa verde $P(a, f e) = t(\text{casa,green})$ $\times t(\text{verde,house})$ $= \frac{1}{3} \times \frac{1}{3} = \frac{1}{9}$</p>	<p>green house \ / casa verde $P(a, f e) = t(\text{verde,green})$ $\times t(\text{casa,house})$ $= \frac{1}{3} \times \frac{1}{3} = \frac{1}{9}$</p>	<p>the house la casa $P(a, f e) = t(\text{la,the})$ $\times t(\text{casa,house})$ $= \frac{1}{3} \times \frac{1}{3} = \frac{1}{9}$</p>	<p>the house \ / la casa $P(a, f e) = t(\text{casa,the})$ $\times t(\text{la,house})$ $= \frac{1}{3} \times \frac{1}{3} = \frac{1}{9}$</p>
--	--	--	--

Note: we're making many simplification assumptions in this example!!

- No NULL word
- We only consider alignments where each French and English word is aligned to something
- We ignore q

EM example: E-step

(b) normalize to get $p(a|f,e)$

green	house
casa	verde

$$P(a|f,e) = \frac{1/9}{2/9} = \frac{1}{2}$$

green	house
\	/
casa	verde

$$P(a|f,e) = \frac{1/9}{2/9} = \frac{1}{2}$$

the	house
la	casa

$$P(a|f,e) = \frac{1/9}{2/9} = \frac{1}{2}$$

the	house
\	/
la	casa

$$P(a|f,e) = \frac{1/9}{2/9} = \frac{1}{2}$$

EM example: E-step

(c) compute expected counts
(weighting each count by $p(a|e,f)$)

$\text{tcount}(\text{casa} \text{green}) = \frac{1}{2}$	$\text{tcount}(\text{verde} \text{green}) = \frac{1}{2}$	$\text{tcount}(\text{la} \text{green}) = 0$	$\text{total}(\text{green}) = 1$
$\text{tcount}(\text{casa} \text{house}) = \frac{1}{2} + \frac{1}{2}$	$\text{tcount}(\text{verde} \text{house}) = \frac{1}{2}$	$\text{tcount}(\text{la} \text{house}) = \frac{1}{2}$	$\text{total}(\text{house}) = 2$
$\text{tcount}(\text{casa} \text{the}) = \frac{1}{2}$	$\text{tcount}(\text{verde} \text{the}) = 0$	$\text{tcount}(\text{la} \text{the}) = \frac{1}{2}$	$\text{total}(\text{the}) = 1$

EM example: M-step

Compute probability estimate by normalizing expected counts

$t(\text{casa} \text{green}) = \frac{1/2}{1} = \frac{1}{2}$	$t(\text{verde} \text{green}) = \frac{1/2}{1} = \frac{1}{2}$	$t(\text{la} \text{green}) = \frac{0}{1} = 0$
$t(\text{casa} \text{house}) = \frac{1}{2} = \frac{1}{2}$	$t(\text{verde} \text{house}) = \frac{1/2}{2} = \frac{1}{4}$	$t(\text{la} \text{house}) = \frac{1/2}{2} = \frac{1}{4}$
$t(\text{casa} \text{the}) = \frac{1/2}{1} = \frac{1}{2}$	$t(\text{verde} \text{the}) = \frac{0}{1} = 0$	$t(\text{la} \text{the}) = \frac{1/2}{1} = \frac{1}{2}$

EM example: next iteration

$$\begin{array}{cc} \text{green} & \text{house} \\ | & | \\ \text{casa} & \text{verde} \end{array}$$
$$P(a, f|e) = t(\text{casa,green})$$
$$\times t(\text{verde,house})$$
$$= \frac{1}{2} \times \frac{1}{4} = \frac{1}{8}$$

$$\begin{array}{cc} \text{green} & \text{house} \\ \diagdown & \diagup \\ \text{casa} & \text{verde} \end{array}$$
$$P(a, f|e) = t(\text{verde,green})$$
$$\times t(\text{casa,house})$$
$$= \frac{1}{2} \times \frac{1}{2} = \frac{1}{4}$$

$$\begin{array}{cc} \text{the} & \text{house} \\ | & | \\ \text{la} & \text{casa} \end{array}$$
$$P(a, f|e) = t(\text{la,the})$$
$$\times t(\text{casa,house})$$
$$= \frac{1}{2} \times \frac{1}{2} = \frac{1}{4}$$

$$\begin{array}{cc} \text{the} & \text{house} \\ \diagdown & \diagup \\ \text{la} & \text{casa} \end{array}$$
$$P(a, f|e) = t(\text{casa,the})$$
$$\times t(\text{la,house})$$
$$= \frac{1}{2} \times \frac{1}{4} = \frac{1}{8}$$

EM for IBM 1 in practice

- The previous example aims to illustrate the intuition of EM algorithm
- But it is a little naïve
 - we had to enumerate all possible alignments
 - very inefficient!!
 - In practice, we don't need to sum overall all possible alignments explicitly for IBM1

<http://www.cs.columbia.edu/~mcollins/courses/nlp2011/notes/ibm12.pdf>

EM

- Procedure for optimizing generative models without supervision
 - ▶ Randomly initialize parameters, then
 - ▶ E: predict hidden structure \mathbf{y} (hard or soft)
 - ▶ M: estimate new parameters $\hat{\mathbf{P}}(\mathbf{y} | \mathbf{x})$ by MLE
- Likelihood function is non-convex. Consider trying several random initializations to avoid getting stuck in local optima.

PHRASE-BASED MODELS

Phrase-based models

- Most common way to model $P(F|E)$ nowadays (instead of IBM models)

$$P(F|E) = \prod_{i=1}^I \phi(\bar{f}_i, \bar{e}_i) d(a_i - b_{i-1})$$

Start position of f_i

End position of $f_{(i-1)}$

Probability of two consecutive English phrases being separated by a particular span in French

Phrase alignments are derived from word alignments

This means that the IBM model represents $P(\text{Spanish} | \text{English})$

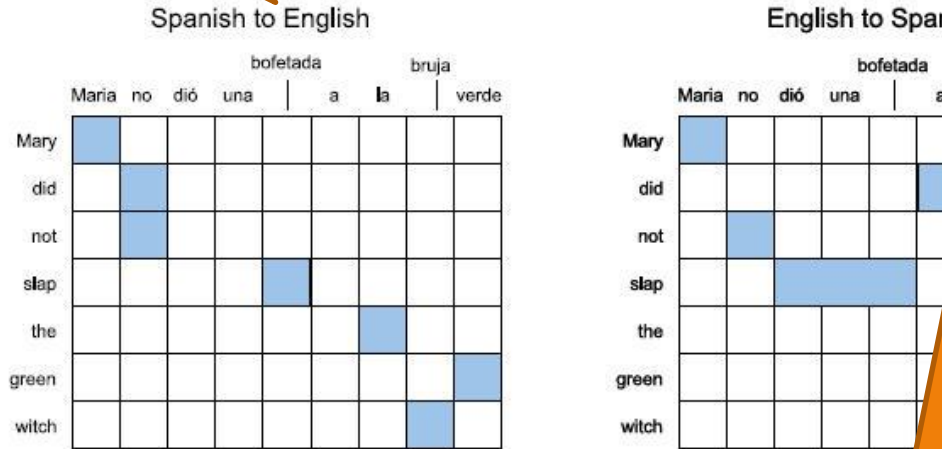

Get high confidence alignment links by intersecting IBM word alignments from both directions

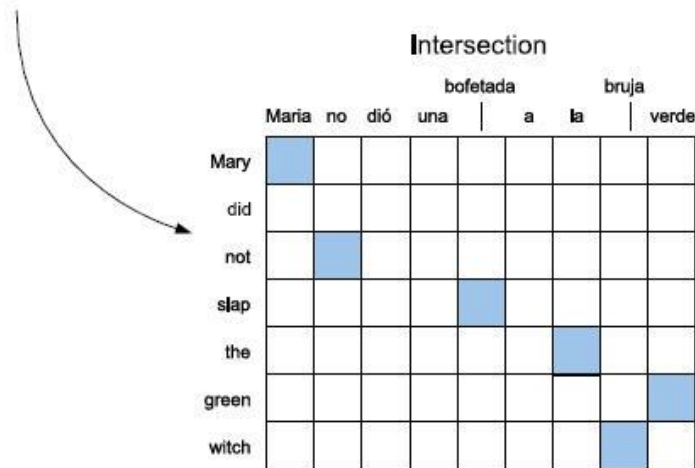

Phrase alignments are derived from word alignments

	Maria	no	dió	una	bofetada	a	la	bruja	verde
Mary	■								
did		■							
not		■							
slap			■						
the					■				
green									■
witch								■	

Improve recall by adding some links from the union of alignments

Phrase alignments are derived from word alignments

	Maria	no	dió	una	bofetada	a	la	bruja	verde
Mary	■								
did		■							
not		■							
slap			■						
the						■			
green									■
witch								■	

(Maria, Mary), (no, did not),
(slap, dió una bofetada), (verde, green),
(a la, the), (bruja, witch),
(Maria no, Mary did not),
(no dió una bofetada, did not slap),
(dió una bofetada a la, slap the),
(bruja verde, green witch),
(a la bruja verde, the green witch),...

Extract phrases that are **consistent**
with word alignment

Phrase Translation Probabilities

- Given such phrases we can get the required statistics for the model from

$$\phi(\bar{f}, \bar{e}) = \frac{\text{count}(\bar{f}, \bar{e})}{\sum_{\bar{f}} \text{count}(\bar{f}, \bar{e})}$$

Phrase-based Machine Translation

$$\hat{E} = \operatorname{argmax}_{E \in \text{English}} \underbrace{P(F|E)}_{\text{translation model}} \underbrace{P(E)}_{\text{language model}}$$
$$\prod_{i \in S} \phi(\bar{f}_i, \bar{e}_i) d(a_i - b_{i-1})$$

DECODING

Decoding for phrase-based MT

- Basic idea
 - search the space of possible English translations in an efficient manner.
 - According to our model

$$\hat{E} = \operatorname{argmax}_{E \in \text{English}} \overbrace{P(F|E)}^{\text{translation model}} \overbrace{P(E)}^{\text{language model}}$$

$$\text{cost}(E, F) = \prod_{i \in S} \phi(\bar{f}_i, \bar{e}_i) d(a_i - b_{i-1}) P(E)$$

Decoding as Search

- Starting point: null state. No French content covered, no English included.
- We'll drive the search by
 - Choosing French word/phrases to "cover",
 - Choosing a way to cover them
- Subsequent choices are pasted left-to-right to previous choices.
- Stop: when all input words are covered.

Decoding

Maria

no

dio

una

bofetada

a

la

bruja

verde

Decoding

Maria	no	dio	una	bofetada	a	la	bruja	verde
-------	----	-----	-----	----------	---	----	-------	-------



Mary

Decoding

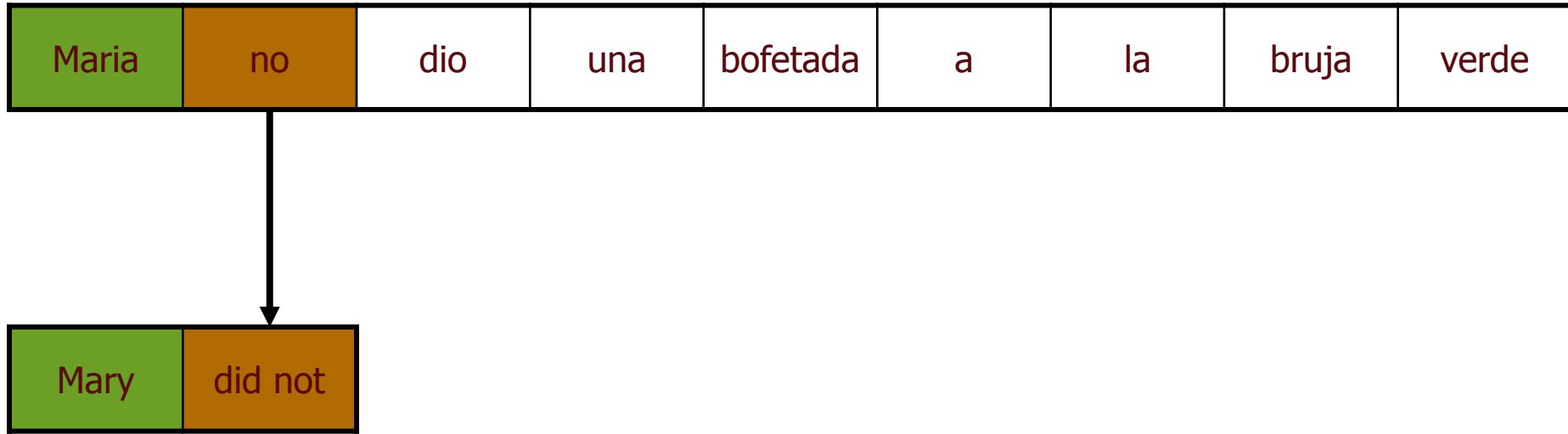

Decoding

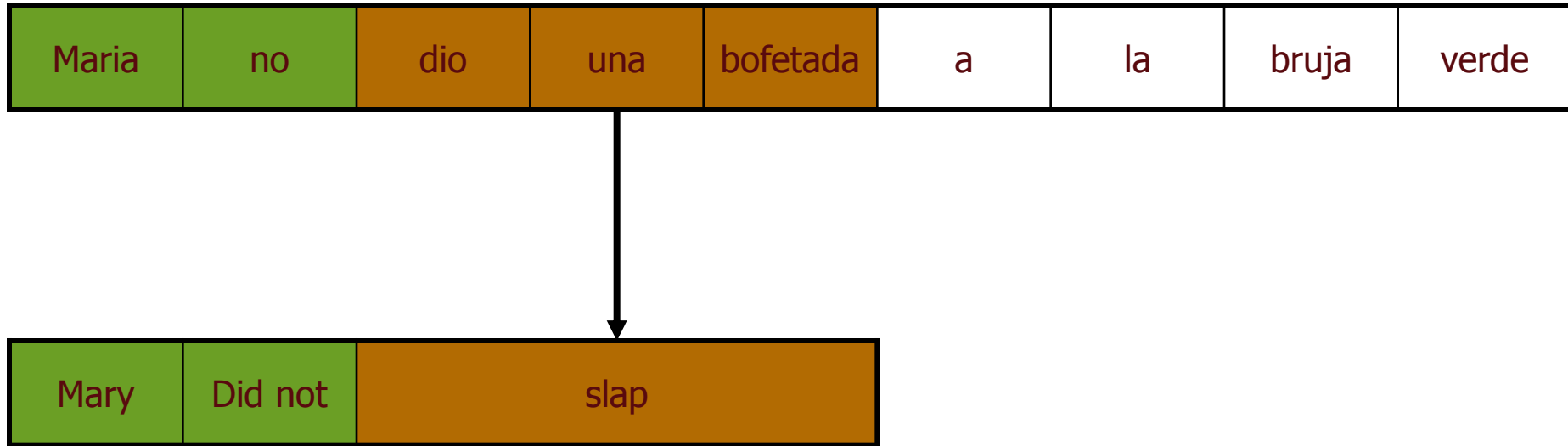

Decoding



Decoding



Decoding

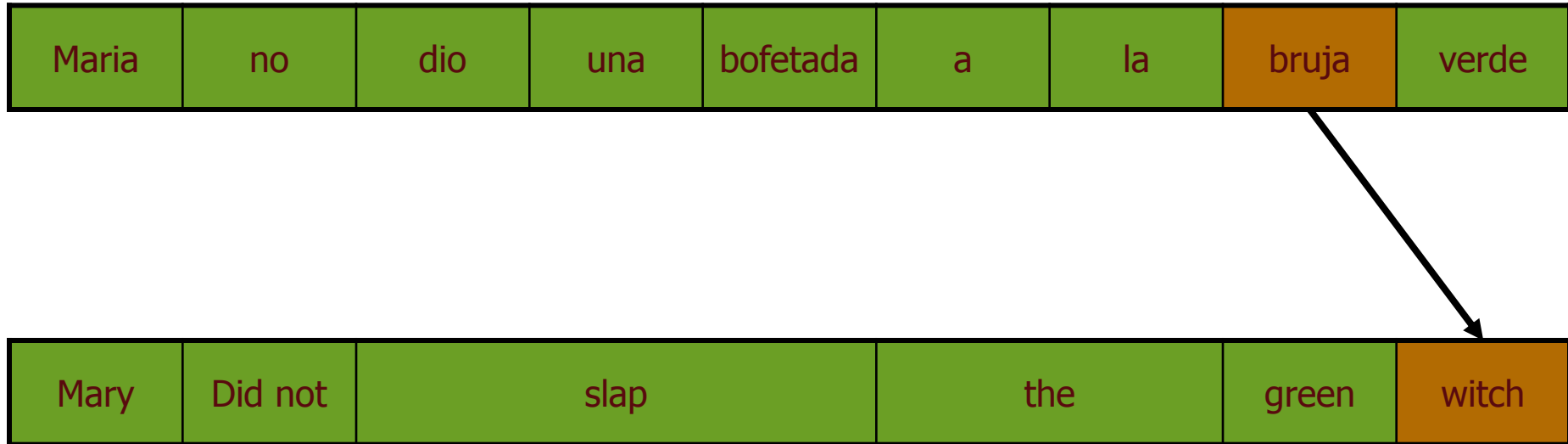

Decoding

Maria

no

dio

una

bofetada

a

la

bruja

verde

Mary

did not

slap

the

green

witch

Phrase-based Machine Translation: the full picture

$$\hat{E} = \operatorname{argmax}_{E \in \text{English}} \underbrace{P(F|E)}_{\text{translation model}} \underbrace{P(E)}_{\text{language model}}$$
$$\prod_{i \in S} \phi(\bar{f}_i, \bar{e}_i) d(a_i - b_{i-1})$$

в этом смысле подобные действия частично дискредитируют систему американской демократии

in this sense such actions some discredit system american democracy

the that meaning similar action partially a system u.s. democracies

a the terms these the part systems us democratic

at it way this acts in part which america of democracy

here sense , like steps partly network america's

this these actions american democracy

in this sense america's democracy

in that sense us democracy

in this respect

Syntax-Based Translation

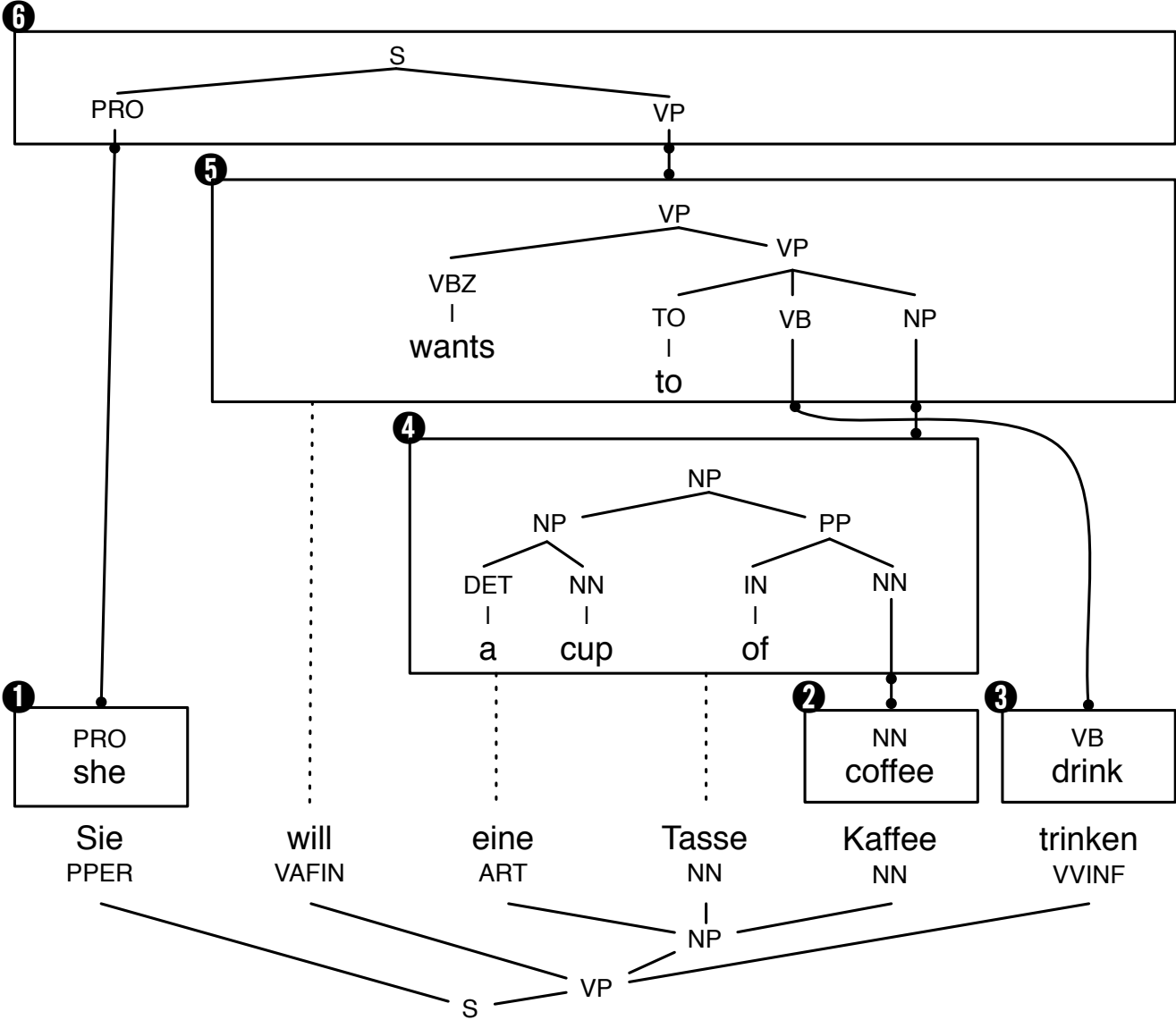

- Abstract meaning representation [Knight et al., ongoing]

```
(w / want-01
  :agent (b / boy)
  :theme (l / love
           :agent (g / girl)
           :patient b))
```

- Generalizes over equivalent syntactic constructs (e.g., active and passive)
- Defines semantic relationships
 - semantic roles
 - co-reference
 - discourse relations
- In a very preliminary stage

Neural MT

- Current research on neural network architectures, with state-of-the-art scores for some language pairs
 - ▶ seq2seq paradigm: next lecture!

MT: Summary

- Human-quality machine translation is an **AI-complete** problem.
 - ▶ All the challenges of NL: ambiguity, flexibility (difficult to evaluate!), vocabulary & grammar divergences between languages, context
 - ▶ State-of-the-art now good *enough* to be useful/commercially successful for some language pairs and purposes.
- Tension: **simplistic models + huge data**, or **linguistically savvy models + less data**? MT systems can be word-level, phrase-based, syntax-based, semantics-based/interlingua (**Vauquois triangle**)
- Statistical methods, enabled by large **parallel corpora** and **automatic evaluations** (such as **BLEU**), are essential for broad coverage
 - ▶ Automatic **word alignment** on parallel data via EM (IBM models)
 - ▶ Noisy channel model: n-gram **language model** for target language + **translation model** that uses probabilities from word alignments
 - ▶ Open-source toolkits like Moses make it relatively easy to build your own MT system from data